

*The*  
*Palladio*  
*Door Collection*

*Edition 7*

*With the new*  
*Avant Garde*  
*Collection*

Dear Customer,

We are proud to present the Palladio Door Collection. We think you will agree that it has been worth waiting for. It is by a long measure, in our opinion, the finest composite door on the market today. In ten years research and development we have left no stone unturned in our quest for the perfect product.

Our approach to this was innovative and radical. The composition of the door differs from all others in its MONOCOQUE structure. This structure gives it a massive strength-to weight ratio and is protected in Europe by patent number 1766176 (Patents in the USA and Canada pending). Apart from the monocoque design there are a lot of other innovative features to this door. For instance, we have designed and manufactured a hinge exclusively for this door, so it is visually concealed unlike the more commonly used flag hinge, which is unsightly. Our glazing system with beads that look like wood is also very attractive. As is evident from the following pages, our wood grain finish is superb, due to the fact that all our tooling is made in house. In a very unique process we replicate exactly the finish of a real oak door, 100% true to the original. Another feature of the door is its excellent U value rating of 0.205 as tested by the "Lambda" testing method.

In addition to this, all our glass is triple glazed and we use edgetech warm edge seals for the lowest U value possible of 0.7. Combined with our new range of Patinated glass designs that consists of a sandblasted glass with a clear border that will give you modern and contemporary design. Our patinated design is achieved through sandblasting not by films or resins that is completely environmentally friendly that will last a lifetime.

We are dedicated to the pursuit of excellence and service to our loyal customers. We take this opportunity to thank you for your continued support. When we say the customer is king it is not an empty platitude, - we mean it!

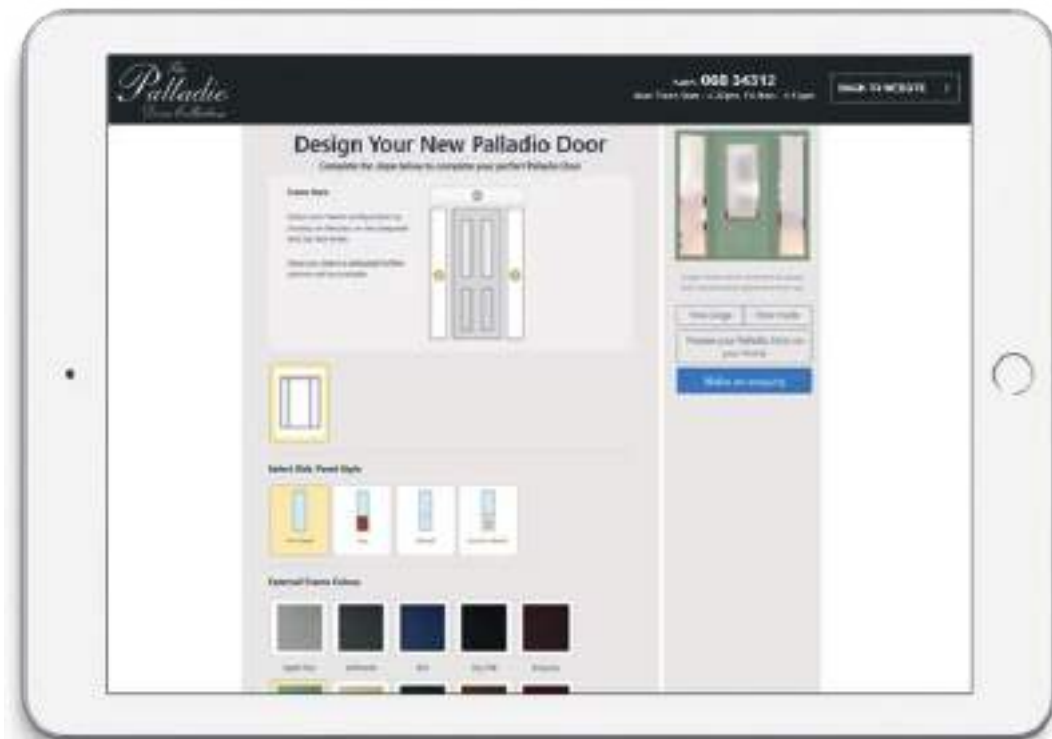

Design your new Door, Go to [www.palladiodoorcollection.com](http://www.palladiodoorcollection.com)



## Profile Developments

## PALLADIO DOOR AND GLASS COLOUR INDEX

DOOR	GLASS	PAGE
Albany	TG501 / TG8/ TG200 Red	31,32
*Barcelona	TG502 / TG503 /TG504	1,2
Belfast	TG501 / TG186 /TG7 Red /TG8	23,24
Cairo	TG65 / TG63 Red / TG53 Red/ TG64 Red	47,48
Cambridge	TG501 / TG74 / TG190 / TG189	9,10
Dublin	TG501 / TG99 / TG160 Red / TG155 Blue	53,54
Edinburgh	TG501 / TG100 / TG8 / TG102	25,26
*Gauguin	TG501	6
Georgian Solid	TG501	13
Georgian 1	TG501 / TG8 / TG77 / TG192	15,16
Georgian 2	TG10 Red / TG76 / TG8	14
Giza	TG105 / TG62	57,59
Joyce	TG501 / TG178 Red / TG8 / TG108	45,46
Kensington	TG501 / TG193 / TG209 Red	33,34
Kildare	TG501 / TG160 Red / TG100 / TG215 Black	43,44
London	TG501 / TG136 Black / TG8 / TG180	19,20
*Madrid	TG505 / TG506	7,8
*Matisse	TG507 / TG508	5,6
*Milan	TG501 / TG502 / TG504	3,4
Monet	TG501 / TG171 / TG179	37
Naples		59
Orpen	TG501 / TG175 Red / TG173 / TG94	39,40
Oxford	TG501 / TG184 / TG202	41,42
Palermo Glazed	TG501 / TG8 / TG23 / TG96 Red	27,28
Palermo Solid	TG501 / TG114 / TG84 / TG8	29,30
Paris	TG501 / TG143 Black / TG78 Red / TG8	17,18
Rome	TG601 Black / TG501 / TG132 Black / TG91 Blue	11,12
San Marco Solid	TG501	38
San Marco	TG16 / TG91 Blue / TG15 / TG157	38
San Tiago	TG59 Black / TG106	57
Seville	TG602 Red / TG501 / TG143 Black / TG8	21,22
Sunbeam 1 / 2	TG41 / TG43 / TG40 Red&Black / TG91 Blue	58
T&G Solid	TG501 / TG109 / TG205 Black / TG68	49,50
T&G	TG501 / TG98 / TG48 / TG100	51,52
Turner	TG501 / TG186 / TG107 Black / TG8	35,36
Viking	TG129 / TG15 / TG100 / TG128 Black	55,56
Sidepanels		59
Accessories		61,62
Specification		60

# Avant Garde Collection

Our new contemporary range of stylish doors are inspired by a demand for modern clean lines that reflect the aspirations of modern architectural homes.

When we set about the task of creating this new collection of doors, we had to be sure we never deviate from the high standard set by our existing Palladio range of doors and adhering to our core values, function and design.

Our new designs are inspired by the work produced by the “Bauhaus Movement” of the 1920’s and the work of Frank Lloyd Wright. We sincerely hope our new designs are sympathetic with the vision you have for your contemporary home.



Door Type - *Barcelona* Glass Type - *TG504 Patinated* (Min. Glass Width 170 mm) Colour *Burgundy*



Door Type - *Barcelona* Glass Type - *TG503 Patinated* (Min. Glass Width 170 mm) Colour *Anthracite Grey*

Doors fitted with a Heritage/Low position Slam Lock, it is recommended to have a PVC threshold or Storm Guard Plus rebated threshold only.

Please Note : Not a Storm Guard or a Storm Guard Plus Threshold.  
Letterbox and door knocker not available on the Avant Garde Collection.  
Stainless Steel strips are optional on the inside of the door leaf.



Door Type - *Barcelona* Glass Type - *TG502 Patinated* (Min. Glass Width 170 mm) Colour *Bog Oak*

Door Type - *Barcelona* Glass Type - *TG503 Patinated* (Min. Glass Width 170 mm) Colour *Chartwell green*

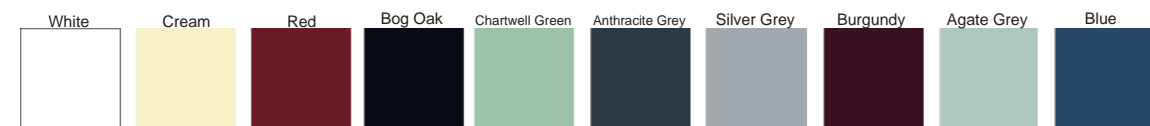

Doors fitted with a Heritage/Low position Slam Lock, it is recommended to have a PVC threshold or Storm Guard Plus rebated threshold only.

Please Note : Not a Storm Guard or a Storm Guard Plus Threshold.  
Letterbox and door knocker not available on the Avant Garde Collection.  
Stainless Steel strips are optional on the inside of the door leaf.



Door Type - Milan Glass Type - TG504 Patinated (Min. Glass Width 170 mm) Colour Anthracite Grey



Door Type - Milan Glass Type - TG501 Patinated (Min. Glass Width 170 mm) Colour Agate Grey

We know what your home means to you. The Avant Garde Collection is an attempt at unleashing the best of our creativity with 316 marine grade stainless steel lines into creating something so beautiful and meaningful as the finest entrance doors for your home.

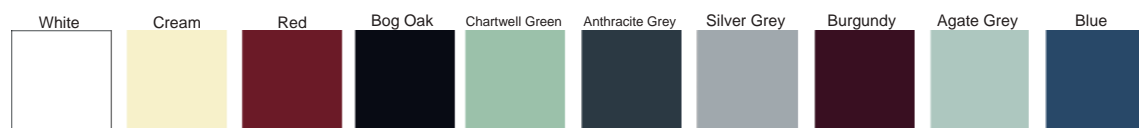

Doors fitted with a Heritage/Low position Slam Lock, it is recommended to have a PVC threshold or Storm Guard Plus rebated threshold only.  
**Please Note : Not a Storm Guard or a Storm Guard Plus Threshold.**  
**Letterbox and door knocker not available on the Avant Garde Collection.**  
**Stainless Steel strips are optional on the inside of the door leaf.**



Door Type - Milan Glass Type - TG502 Patinated (Min. Glass Width 170 mm) Colour Bog Oak

Doors fitted with a Heritage/Low position Slam Lock, it is recommended to have a PVC threshold or Storm Guard Plus rebated threshold only.  
**Please Note : Not a Storm Guard or a Storm Guard Plus Threshold.**  
**Letterbox and door knocker not available on the Avant Garde Collection.**  
**Stainless Steel strips are optional on the inside of the door leaf.**



*Door Type - Matisse Glass Type - TG507 Patinated (Min. Glass Width 170 mm) Colour Anthracite Grey*

*Doors fitted with a Heritage/Low position Slam Lock, it is recommended to have a PVC threshold or Storm Guard Plus rebated threshold only.  
Please Note : Not a Storm Guard or a Storm Guard Plus Threshold.  
Letterbox and door knocker not available on the Avant Garde Collection.  
Stainless Steel strips are optional on the inside of the door leaf.*



*Door Type - Gauguin Glass Type - TG501 Patinated (Min. Glass Width 170 mm) Colour Red*



*Door Type - Matisse Glass Type - TG508 Patinated (Min. Glass Width 170 mm) Colour Silver Grey*

*Doors fitted with a Heritage/Low position Slam Lock, it is recommended to have a PVC threshold or Storm Guard Plus rebated threshold only.  
Please Note : Not a Storm Guard or a Storm Guard Plus Threshold.  
Letterbox and door knocker not available on the Avant Garde Collection.  
Stainless Steel strips are optional on the inside of the door leaf.*



*Door Type - Madrid Glass Type - TG505 Patinated (Min. Glass Width 170 mm) Colour Anthracite Grey*

The Avant Garde Collection is ultra-sleek and will add a modern twist to your home while most importantly ensuring to keep you and your home safe and secure.

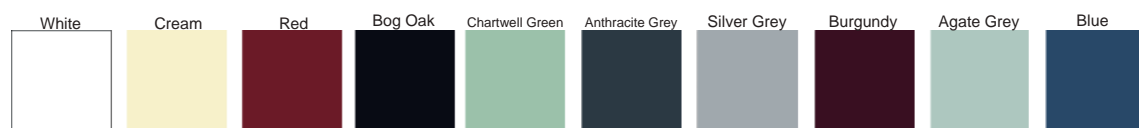

*Doors fitted with a Heritage/Low position Slam Lock, it is recommended to have a PVC threshold or Storm Guard Plus rebated threshold only.*

**Please Note : Not a Storm Guard or a Storm Guard Plus Threshold.  
Letterbox and door knocker not available on the Avant Garde Collection.  
Stainless Steel strips are optional on the inside of the door leaf.**



*Door Type - Madrid Glass Type - TG505 Patinated (Min. Glass Width 170 mm) Colour Anthracite Grey*

Doors viewed from the inside  
optional stainless steel strips.



*Door Type - Madrid Glass Type - TG505 Patinated (Min. Glass Width 170 mm) Colour Silver Grey*

*Door Type - Madrid Glass Type - TG506 Patinated (Min. Glass Width 170 mm) Colour White*

*Doors fitted with a Heritage/Low position Slam Lock, it is recommended to have a PVC threshold or Storm Guard Plus rebated threshold only.*

**Please Note : Not a Storm Guard or a Storm Guard Plus Threshold.  
Letterbox and door knocker not available on the Avant Garde Collection.  
Stainless Steel strips are optional on the inside of the door leaf.**



*Door Type - Cambridge Glass Type - TG501 Patinated  
(Min. Glass Width 170 mm) Colour Bog Oak*



*Door Type - Cambridge  
Glass Type - TG189 Satinized  
(Min. Glass Width 240 mm)  
Colour Anthracite Grey*

The Palladio Collection is triple glazed as standard across the range. All doors have a renolit foil finish. With 13 stunning colours to choose from and with the same matching foil finish on each frame, this results in a perfect colour match with an extremely durable and robust finish.



*Door Type - Cambridge Glass Type - TG190  
(Min. Glass Width 240 mm) Colour Agate Grey*

*Door Type - Cambridge Glass Type - TG74  
(Min. Glass Width 250 mm) Colour Burgundy*

*Doors fitted with a Heritage Slam Lock, it is recommended to have a PVC threshold or Storm Guard Plus rebated threshold only.  
Please Note : Not a Storm Guard or a Storm Guard Plus Threshold.*

Our new Patinated technique has allowed us to create elegant and contemporary glass designs to suit our vast range of door styles

*Please Note - All Doors on this page supplied with spy view as standard.*



*Door Type - Rome Glass Type - TG601 Patinated (Min. Glass Width 170 mm) Colour Anthracite Grey*

Introducing a new range of Fused glass tiles that will create stunning Doorways and Sidelights when incorporated with our Patinated glass without the use of resin lines, giving a modern and contemporary look to your home!



*Doors fitted with a Heritage Slam Lock, it is recommended to have a PVC threshold or Storm Guard Plus rebated threshold only. Please Note : Not a Storm Guard or a Storm Guard Plus Threshold.*

*Please Note - All Doors on this page supplied with spy view as standard.*



*Door Type - Rome Glass Type - TG501 Patinated (Min. Glass Width 170 mm) Colour Silver Grey*



*Door Type - Rome Glass Type - TG132 Satinized (Min. Glass Width 200 mm) Colour Anthracite Grey*



*Door Type - Rome Glass Type - TG91 Satinized (Min. Glass Width 150 mm) Colour Blue*

*Doors fitted with a Heritage Slam Lock, it is recommended to have a PVC threshold or Storm Guard Plus rebated threshold only. Please Note : Not a Storm Guard or a Storm Guard Plus Threshold.*





Door Type - Georgian Solid Glass Type - TG501 Patinated  
(Min. Glass Width 170 mm) Colour Agate Grey



A fine example of our satinized glass for doors and sidelights. This product is produced in-house and is quite unique in its crystal-like appearance as is evident in the picture on the left.

Door Type - Georgian 2 Glass Type - TG10 Satinized  
(Min. Glass Width 230mm) Colour Green



Door Type - Georgian 2 Glass Type - TG76  
(Min. Glass Width 200 mm) Colour Red



Door Type - Georgian 2 Glass Type - TG8  
(Min. Glass Width 155mm) Colour Anthracite Grey



The Georgian 1 Style is a classic design with a contemporary influence through our unique glass designs. The woodgrain effect that is lifted from a real oak door compliments this design.



Door Type - Georgian 1 Glass Type - TG501 Patinated (Min. Glass Width 170 mm) Colour Burgundy



Door Type - Georgian 1 Glass Type - TG8 (Min. Glass Width 155mm) Colour Anthracite Grey



Door Type - Georgian 1 Glass Type - TG77 satinized (Min. Glass Width 150mm) Colour Chartwell Green

Door Type - Georgian 1 Glass Type - TG192 (Min. Glass Width 240mm) Colour Burgundy

Doors fitted with a Heritage Slam Lock, it is recommended to have a PVC threshold or Storm Guard Plus rebated threshold only. Please Note : Not a Storm Guard or a Storm Guard Plus Threshold.

Doors fitted with a Heritage Slam Lock, it is recommended to have a PVC threshold or Storm Guard Plus rebated threshold only. Please Note : Not a Storm Guard or a Storm Guard Plus Threshold.

*Please Note - All Doors on this page supplied with spy view as standard.*



*Door Type - Paris Glass Type - TG501 Patinated (Min. Glass Width 170 mm) Colour Agate Grey*



*Door Type - Paris Glass Type - TG143 Satinized (Min. Glass Width 200 mm) Colour Burgundy*

*Door Type - Paris Glass Type - TG78 Satinized (Min. Glass Width 150 mm) Colour Blue*



*Door Type - Paris Glass Type - TG8 (Min. Glass Width 155 mm) Colour Silver Grey*

*Please Note - All Doors on this page supplied with spy view as standard.*

*Doors fitted with a Heritage Slam Lock, it is recommended to have a PVC threshold or Storm Guard Plus rebated threshold only. Please Note : Not a Storm Guard or a Storm Guard Plus Threshold.*



*Please Note - All Doors on this page supplied with spy view as standard.*



*Door Type - London Glass Type - TG501 Patinated  
(Min. Glass Width 170 mm) Colour Anthracite Grey*

*Doors fitted with a Heritage Slam Lock, it is recommended to have a PVC threshold or Storm Guard Plus rebated threshold only.  
Please Note : Not a Storm Guard or a Storm Guard Plus Threshold.*

*Please Note - All Doors on this page supplied with spy view as standard.*



*Door Type - London Glass Type - TG136 Satinized  
(Min. Glass Width 140 mm) Colour Red*



*Door Type - London Glass Type - TG8  
(Min. Glass Width 200 mm) Colour Agate Grey*

*Door Type - London Glass Type - TG180 Satinized  
(Min. Glass Width 200 mm) Colour Bog Oak*

*Doors fitted with a Heritage Slam Lock, it is recommended to have a PVC threshold or Storm Guard Plus rebated threshold only.  
Please Note : Not a Storm Guard or a Storm Guard Plus Threshold.*



Introducing a new range of Fused glass tiles that will create stunning Doorways and Sidelights when incorporated with our Patinated glass without the use of resin lines, giving a modern and contemporary look to your home!



Doors fitted with a Heritage Slam Lock, it is recommended to have a PVC threshold or Storm Guard Plus rebated threshold only.  
 Please Note : Not a Storm Guard or a Storm Guard Plus Threshold,  
 Letterbox available only on the low position.

*Please Note - All Doors on this page supplied with spy view as standard.*



*Door Type - Belfast Glass Type - TG501 Patinated  
(Min. Glass Width 170 mm)  
Colour Silver Grey*

*Doors fitted with a Heritage Slam Lock, it is recommended to have a PVC threshold or Storm Guard Plus rebated threshold only.  
Please Note : Not a Storm Guard or a Storm Guard Plus Threshold,  
Letterbox available only on the low position.*

*Please Note - All Doors on this page supplied with spy view as standard.*



*Door Type - Belfast Glass Type - TG186 Satinized  
(Min. Glass Width 140 mm) Colour Anthracite Grey*



*Door Type - Belfast Glass Type - TG7  
(Min. Glass Width 210 mm) Colour Red*

*Door Type - Belfast Glass Type - TG8  
(Min. Glass Width 155 mm) Colour Agate Grey*

*Doors fitted with a Heritage Slam Lock, it is recommended to have a PVC threshold or Storm Guard Plus rebated threshold only.  
Please Note : Not a Storm Guard or a Storm Guard Plus Threshold,  
Letterbox available only on the low position.*



*Door Type - Edinburgh Glass Type - TG501 Patinated  
(Min. Glass Width 170 mm) Colour Bog Oak*



*Door Type - Edinburgh Glass Type - TG100  
(Min. Glass Width 250 mm) Colour Anthracite Grey*



*Door Type - Edinburgh Glass Type - TG8  
(Min. Glass Width 155 mm) Colour Blue*

*Door Type - Edinburgh Glass Type - TG102  
(Min. Glass Width 155 mm) Colour Burgundy*



*Doors fitted with a Heritage Slam Lock, it is recommended to have a PVC threshold or Storm Guard Plus rebated threshold only.  
Please Note : Not a Storm Guard or a Storm Guard Plus Threshold.*



The Palermo door is our best selling design and compliments all entrance styles

Door Type - Palermo Glass Type - TG501 Patinated (Min. Glass Width 170 mm) - Colour Silver Grey



Doors fitted with a Heritage Slam Lock, it is recommended to have a PVC threshold or Storm Guard Plus rebated threshold only. Please Note : Not a Storm Guard or a Storm Guard Plus Threshold.

Door Type - Palermo Glass Type - TG8 (Min. Glass Width 155mm) Colour Burgundy

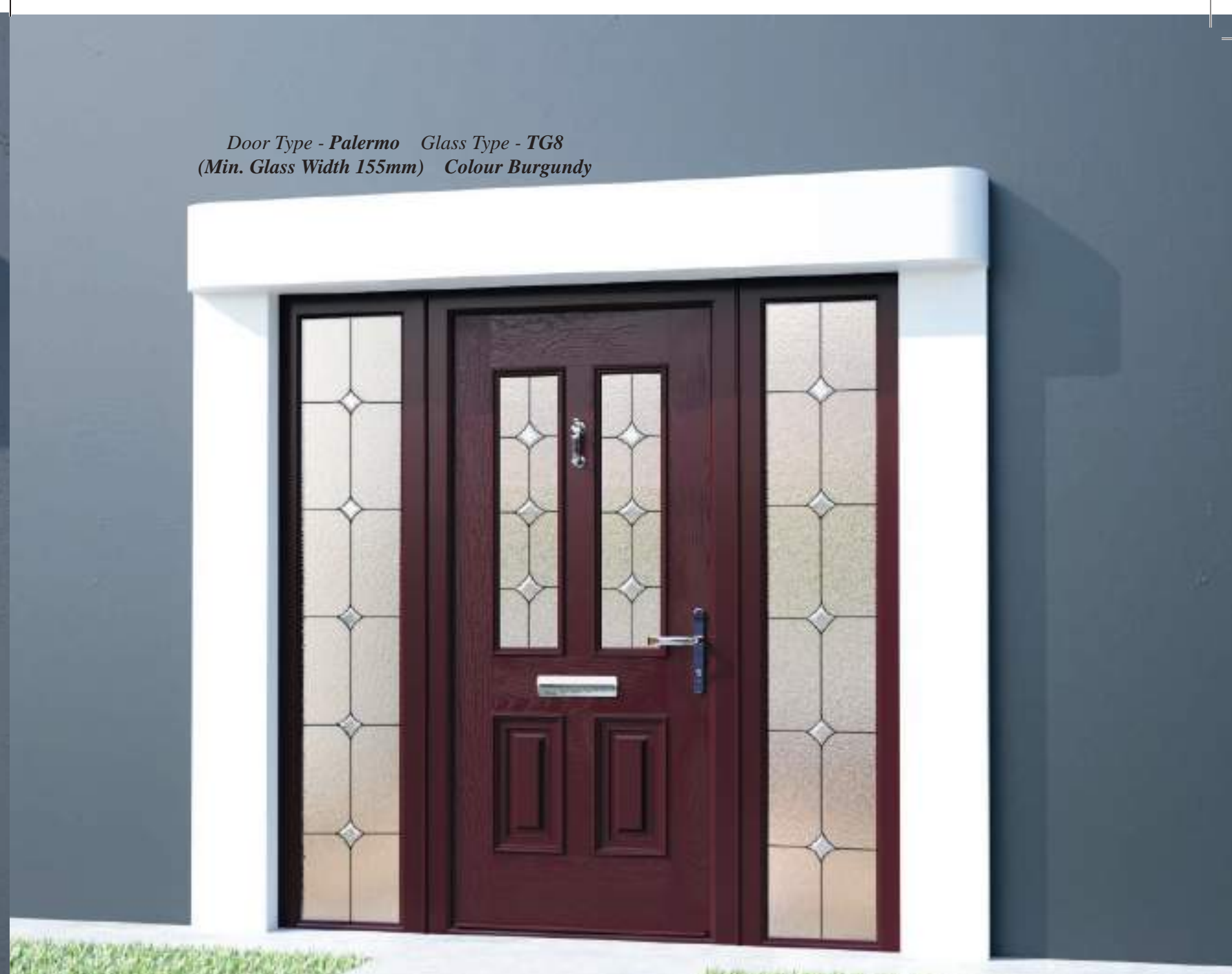

Door Type - Palermo Glass Type - TG23 (Min. Glass Width 250 mm) Colour Anthracite Grey

Door Type - Palermo Glass Type - TG96 Satinized (Min. Glass Width 150 mm) Colour Bog Oak

Doors fitted with a Heritage Slam Lock, it is recommended to have a PVC threshold or Storm Guard Plus rebated threshold only. Please Note : Not a Storm Guard or a Storm Guard Plus Threshold.





*Door Type - Palermo Solid Glass Type - TG501 Patinated (Min. Glass Width 170 mm) - Colour Red*



*Glass Type - TG6 Fanlight*



*Door Type - Palermo Solid  
Glass Type - TG114  
(Min. Glass Width 270mm)  
Colour Bog Oak*



*Door Type - Palermo Solid Glass Type - TG84  
(Min. Glass Width 210 mm) - Colour Green*

*Door Type - Palermo Solid Glass Type - TG8  
(Min. Glass Width 170 mm) - Colour Blue*



*Doors fitted with a Heritage Slam Lock, it is recommended to have a PVC threshold or Storm Guard Plus rebated threshold only.  
Please Note : Not a Storm Guard or a Storm Guard Plus Threshold.*



*Door Type - Albany*      *Glass Type - TG501 Patinated*  
*(Min. Glass Width 170mm)*      *Colour Blue*

Doors fitted with a Heritage Slam Lock, it is recommended to have a PVC threshold or Storm Guard Plus rebated threshold only.  
 Please Note : Not a Storm Guard or a Storm Guard Plus Threshold,  
 Letterbox available only on the low position.



*Door Type - Albany*  
*Glass Type - TG8*  
*(Min. Glass Width 170mm)*  
*Colour Silver Grey*



*Door Type - Albany*  
*Glass Type - TG200 Satinized*  
*(Min. Glass Width 140mm)*  
*Colour Red*

Doors fitted with a Heritage Slam Lock, it is recommended to have a PVC threshold or Storm Guard Plus rebated threshold only.  
 Please Note : Not a Storm Guard or a Storm Guard Plus Threshold,  
 Letterbox available only on the low position.

*Please Note - All Doors on this page supplied with spy view as standard. Letterbox available only on the low position.*



**Door Type - Kensington Glass Type - TG501 Patinated (Min. Glass Width 170mm) Colour Red**



*Please Note - All Doors on this page supplied with spy view as standard.*

**Door Type - Kensington  
Glass Type - TG193 Satinized  
(min. Glass Width 200mm)  
Colour Silver Grey**



**Door Type - Kensington  
Glass Type - TG209  
(min. Glass Width 210mm)  
Colour Anthracite Grey**



*Doors fitted with a Heritage Slam Lock, it is recommended to have a PVC threshold or Storm Guard Plus rebated threshold only.*

**Please Note : Not a Storm Guard or a Storm Guard Plus Threshold, Letterbox available only on the low position.**

*Please Note - All Doors on this page supplied with spy view as standard.*



*Door Type - Turner Glass Type - TG501 Patinated (Min. Glass Width 170 mm) - Colour Blue*



Doors fitted with a Heritage Slam Lock, it is recommended to have a PVC threshold or Storm Guard Plus rebated threshold only.  
**Please Note : Not a Storm Guard or a Storm Guard Plus Threshold.**

*Please Note - All Doors on this page supplied with spy view as standard.*



*Door Type - Turner Glass Type - TG186 Satinized (Min. Glass Width 140 mm) - Colour Agate Grey*



*Door Type - Turner Glass Type - TG107 Satinized (Min. Glass Width 240 mm) - Colour Silver Grey*

*Door Type - Turner Glass Type - TG8 (Min. Glass Width 155 mm) - Colour Bog Oak*

Doors fitted with a Heritage Slam Lock, it is recommended to have a PVC threshold or Storm Guard Plus rebated threshold only.  
**Please Note : Not a Storm Guard or a Storm Guard Plus Threshold.**



Door Type - **Monet** Glass Type - **TG501 Patinated** (Min. Glass Width 170 mm) Colour **Red**



Door Type - **San Marco** Glass Type - **TG16** Colour **Red**



Door Type - **San Marco** Glass Type - **TG91 Satinized** (Min. Glass Width 150 mm) Colour **Burgundy**



Door Type - **San Marco** Glass Type - **TG15** (Min. Glass Width 150 mm) Colour **Blue**



Door Type - **Monet** Glass Type - **TG171 Satinized** (Min. Glass Width 240 mm) Colour **Burgundy**



Door Type - **Monet** Glass Type - **TG179 Satinized** (Min. Glass Width 300 mm) Colour **Chartwell Green**



Door Type - **San Marco Solid** Glass Type - **TG501 Pantinated** (Min. Glass Width 170 mm) Colour **Bog Oak**



Door Type - **San Marco** Glass Type - **TG157 Satinized** (Min. Glass Width 200 mm) Colour **Anthracite Grey**

Doors fitted with a Heritage Slam Lock, it is recommended to have a PVC threshold or Storm Guard Plus rebated threshold only.  
Please Note : Not a Storm Guard or a Storm Guard Plus Threshold.

*Please Note - All Doors on this page supplied with spy view as standard.*



**Door Type - Orpen Glass Type - TG501 Patinated (Min. Glass Width 170 mm) Colour Bog Oak**



**Door Type - Orpen Glass Type - TG175 Satinized (Min. Glass Width 120 mm) - Colour Red**



*Please Note - All Doors on this page supplied with spy view as standard.*

**Door Type - Orpen Glass Type - TG173 Satinized (Min. Glass Width 110 mm) Colour Agate Grey**

**Door Type - Orpen Glass Type - TG94 Satinized (Min. Glass Width 150 mm) Colour Blue**

*Doors fitted with a Heritage Slam Lock, it is recommended to have a PVC threshold or Storm Guard Plus rebated threshold only. Please Note : Not a Storm Guard or a Storm Guard Plus Threshold.*

*Please Note - All Doors on this page supplied with spy view as standard.*



**Door Type - Oxford Glass Type - TG501 Patinated**  
**(min. Glass Width 170mm) Colour Agate Grey**



*Please Note - All Doors on this page supplied with spy view as standard.*



**Door Type - Oxford Glass Type - TG184 Satinized** (Min. Glass Width 120mm) **Colour Anthracite Grey**



**Door Type - Oxford Glass Type - TG202**  
**(Min. Glass Width 200mm) Colour Burgundy**

*Doors fitted with a Heritage Slam Lock, it is recommended to have a PVC threshold or Storm Guard Plus rebated threshold only. Please Note : Not a Storm Guard or a Storm Guard Plus Threshold.*

The Oxford is a stunning design, manufactured to suit the modern and contemporary home.



*Door Type - Kildare Glass Type - TG501 Patinated  
(Min. Glass Width 170 mm) Colour Agate Grey*



*Door Type - Kildare Glass Type - TG160 Satinized  
(Min. Glass Width 200 mm) Colour Green*

*Door Type - Kildare Glass Type - TG100  
(Min. Glass Width 250 mm) Colour Bog Oak*



*Door Type - Kildare Glass Type - TG215 (Min. Glass Width 140mm) Colour Silver Grey*







Door Type - Joyce Glass Type - TG501 Patinated (Min. Glass Width 170 mm) Colour Red



Door Type - Joyce Glass Type - TG178 Satinized (Min. Glass Width 240mm) Colour Blue



Door Type - Joyce Glass Type - TG8 (Min. Glass Width 155 mm) Colour Burgundy

Door Type - Joyce Glass Type - TG108 Satinized (Min. Glass Width 200 mm) Colour Agate Grey





*Door Type - Cairo Glass Type - TG65  
(Min. Glass Width 240 mm) Colour Bog Oak*



*Door Type - Cairo Glass Type - TG63 Satinized  
(Min. Glass Width 160 mm) Colour Red*



*Door Type - Cairo Glass Type - TG53 Satinized  
(Min. Glass Width 160 mm) Colour Burgundy*

*Door Type - Cairo Glass Type - TG64  
(Min. Glass Width 160 mm) Colour Anthracite Grey*



*Doors fitted with a Heritage Slam Lock, it is recommended to have a PVC threshold or Storm Guard Plus rebated threshold only.  
Please Note : Not a Storm Guard or a Storm Guard Plus Threshold.*

*Please Note - All Doors on this page supplied with spy view as standard or with a spyview knocker as an optional extra.*



*Door Type - T&G Solid  
Glass Type - TG501 Patinated  
(Min. Glass Width 170 mm)  
Colour Blue*



*Please Note - All Doors on this page supplied with spy view as standard or with a spyview knocker as an optional extra.*



*Door Type - T&G Solid Glass Type - TG109  
(Min. Glass Width 210 mm) Colour light oak*



*Door Type - T&G Solid Glass Type - TG205 Satinized  
(Min. Glass Width 140 mm) Colour Chartwell Green*

All Door Styles on this page are available with Contemporary Cranked Pullbar Handle supplied with Heritage Slam Locking System. Option of Fingerpull Escutcheon or Traditional Lever Handles are also available.



*Door Type - T&G Solid Glass Type - TG68  
(Min. Glass Width 200 mm) Colour Anthracite Grey*

*Doors fitted with a Heritage Slam Lock, it is recommended to have a PVC threshold or Storm Guard Plus rebated threshold only.  
Please Note : Not a Storm Guard or a Storm Guard Plus Threshold.*



Door Type - T&G  
Glass Type - TG501 Patinated  
(Min. Glass Width 170 mm)  
Colour Green



Door Type - T&G Glass Type - TG98 (Min. Glass Width 210 mm) Colour Bog Oak



Door Type - T&G Glass Type - TG48  
(Min. Glass Width 300 mm) Colour Agate Grey

Door Type - T&G Glass Type - TG100  
(Min. Glass Width 250 mm) Colour Burgundy



Doors fitted with a Heritage Slam Lock, it is recommended to have a PVC threshold or Storm Guard Plus rebated threshold only.  
Please Note : Not a Storm Guard or a Storm Guard Plus Threshold.



*Door Type - Dublin Glass Type - TG501 Patinated  
(Min. Glass Width 170 mm) Colour Anthracite Grey*



*Door Type - Dublin Glass Type - TG99 (Min. Glass Width 210 mm) Colour Chartwell Green*



*Door Type - Dublin Glass Type - TG160 Satinized  
(Min. Glass Width 200 mm) Colour Red*

*Door Type - Dublin Glass Type - TG155  
(Min. Glass Width 140 mm) Colour Bog Oak*

*Doors fitted with a Heritage Slam Lock, it is recommended to have a PVC threshold or Storm Guard Plus rebated threshold only.  
Please Note : Not a Storm Guard or a Storm Guard Plus Threshold.*



Door Type - Viking Glass Type - TG129 Satinized  
(Min. Glass Width 300 mm) Colour Chartwell Green



Doors fitted with a Heritage Slam Lock, it is recommended to have a PVC threshold or Storm Guard Plus rebated threshold only.  
Please Note : Not a Storm Guard or a Storm Guard Plus Threshold.



Door Type - Viking Glass Type - TG15  
(Min. Glass Width 150 mm) Colour Anthracite Grey



Door Type - Viking Glass Type - TG100  
(Min. Glass Width 250 mm) Colour Blue

Door Type - Viking Glass Type - TG128 Satinized  
(Min. Glass Width 200 mm) Colour Red

Doors fitted with a Heritage Slam Lock, it is recommended to have a PVC threshold or Storm Guard Plus rebated threshold only.  
Please Note : Not a Storm Guard or a Storm Guard Plus Threshold.



Door Type - *San Tiago* Glass Type - *TG59*  
(Min. Glass Width 210 mm) Colour *Agate Grey*



Door Type - *Giza* Glass Type - *TG105*  
(Min. Glass Width 155 mm) Colour *Chartwell green*



Door Type - *Giza* Glass Type - *TG62*  
(Min. Glass Width 330 mm) Colour *Rosewood*



Door Type - *San Tiago* Glass Type - *TG106*  
Colour *Red*



Door Type - *Sunbeam 1* Glass Type - *TG41*  
Colour *Bog Oak*



Door Type - *Sunbeam 2* Glass Type - *TG41*  
(Min. Glass Width 150 mm) Colour *Red*



Door Type - *Sunbeam 2* Glass Type - *TG43*  
(Min. Glass Width 210 mm) Colour *Anthracite Grey*

High Security Finger Pull Escutcheon created to compliment both contemporary and period door designs.

The cylinder is protected behind a steel security shield with a reduced risk of cylinder attack, snapping or drilling.

All doors on this page are available with Curved or Pullbar Handle supplied with Heritage slam Locking System. Option of Fingerpull Escutcheon or Traditional Lever Handles also available



Door Type - *Sunbeam 2* Glass Type - *TG40*  
(Min. Glass Width 210 mm) Colour *Blue*

Door Type - *Sunbeam 2* Glass Type - *TG91 Satinized*  
(Min. Glass Width 150 mm) Colour *Burgundy*



Door Type - Giza



Door Type - Naples

Obscure Glass



Stippolyte



Minster

Side Panels

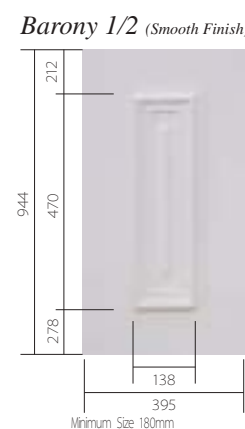
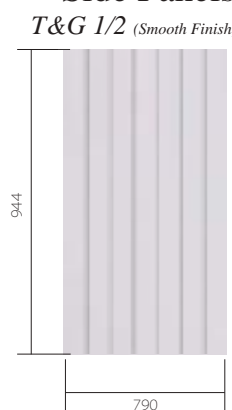
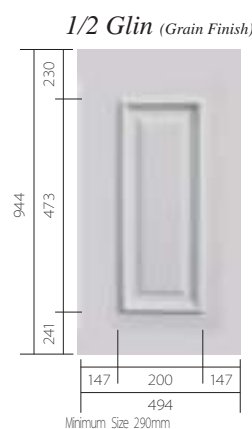

# The Palladio Door Collection

## Specifications

Palladio Doors	65mm fibreglass reinforced Monocoque Composite Door, Patented Design protected in Europe by patent no 1766176, Canadian and US Pending																																
Palladio Colours	White, Cream, Red, Blue, Green, Bog Oak, Rosewood, Anthracite Grey, Chartwell Green, Light Oak, Silver Grey, Agate Grey and Burgundy. <i>Please note: Half Sidelight Panels are not available in Silver Grey, Agate Grey or Burgundy.</i>																																
Avant Garde Colours	White, Cream, Red, Blue, Bog Oak, Chartwell Green, Anthracite grey, Silver grey, Burgundy, Agate grey																																
Double Rebate	Double rebate using two seals achieving excellent draught proofing																																
Single Door Slab Size	<table border="0"> <tr> <th colspan="2"><i>Palladio Collection</i></th> <th colspan="2"><i>Avant garde Collection</i></th> </tr> <tr> <td>Leaf Min. 782 mm x 1855mm</td> <td>Single Door Min, 878 mm x1951</td> <td>Leaf Min. 782 mm x 1855mm</td> <td>Single Door Min, 878 mm x1951</td> </tr> <tr> <td>Only Max 910mm x 2095 mm</td> <td>With Frame Max 1006 mm x 2191mm</td> <td>Only Max 970mm x 2135 mm</td> <td>With Frame Max 1066 mm x 2231mm</td> </tr> <tr> <td colspan="2"><i>Please note: Minimum Size 858 with 57mm frame on lock side.</i></td> <td colspan="2"><i>Please note: Minimum Size 858 with 57mm frame on lock side.</i></td> </tr> <tr> <td colspan="2"><i>With low Stormguard Plus threshold, max height 2181mm, min 1942mm</i></td> <td colspan="2"><i>With low Stormguard Plus threshold, max height 2221mm, min 1942mm</i></td> </tr> <tr> <td colspan="2"><i>With low Stormguard Plus rebated, max height 2162mm, min 1922mm</i></td> <td colspan="2"><i>With low Stormguard Plus rebated, max height 2202mm, min 1922mm</i></td> </tr> <tr> <td colspan="2"><i>With low Stormguard threshold, max height 2163mm, min 1923mm</i></td> <td colspan="2"><i>With low Stormguard threshold, max height 2203mm, min 1923mm</i></td> </tr> <tr> <td colspan="2"><i>With 57mm uPVC threshold, max height 2171mm, min 1931mm</i></td> <td colspan="2"><i>With 57mm uPVC threshold, max height 2211mm, min 1931mm</i></td> </tr> </table>	<i>Palladio Collection</i>		<i>Avant garde Collection</i>		Leaf Min. 782 mm x 1855mm	Single Door Min, 878 mm x1951	Leaf Min. 782 mm x 1855mm	Single Door Min, 878 mm x1951	Only Max 910mm x 2095 mm	With Frame Max 1006 mm x 2191mm	Only Max 970mm x 2135 mm	With Frame Max 1066 mm x 2231mm	<i>Please note: Minimum Size 858 with 57mm frame on lock side.</i>		<i>Please note: Minimum Size 858 with 57mm frame on lock side.</i>		<i>With low Stormguard Plus threshold, max height 2181mm, min 1942mm</i>		<i>With low Stormguard Plus threshold, max height 2221mm, min 1942mm</i>		<i>With low Stormguard Plus rebated, max height 2162mm, min 1922mm</i>		<i>With low Stormguard Plus rebated, max height 2202mm, min 1922mm</i>		<i>With low Stormguard threshold, max height 2163mm, min 1923mm</i>		<i>With low Stormguard threshold, max height 2203mm, min 1923mm</i>		<i>With 57mm uPVC threshold, max height 2171mm, min 1931mm</i>		<i>With 57mm uPVC threshold, max height 2211mm, min 1931mm</i>	
<i>Palladio Collection</i>		<i>Avant garde Collection</i>																															
Leaf Min. 782 mm x 1855mm	Single Door Min, 878 mm x1951	Leaf Min. 782 mm x 1855mm	Single Door Min, 878 mm x1951																														
Only Max 910mm x 2095 mm	With Frame Max 1006 mm x 2191mm	Only Max 970mm x 2135 mm	With Frame Max 1066 mm x 2231mm																														
<i>Please note: Minimum Size 858 with 57mm frame on lock side.</i>		<i>Please note: Minimum Size 858 with 57mm frame on lock side.</i>																															
<i>With low Stormguard Plus threshold, max height 2181mm, min 1942mm</i>		<i>With low Stormguard Plus threshold, max height 2221mm, min 1942mm</i>																															
<i>With low Stormguard Plus rebated, max height 2162mm, min 1922mm</i>		<i>With low Stormguard Plus rebated, max height 2202mm, min 1922mm</i>																															
<i>With low Stormguard threshold, max height 2163mm, min 1923mm</i>		<i>With low Stormguard threshold, max height 2203mm, min 1923mm</i>																															
<i>With 57mm uPVC threshold, max height 2171mm, min 1931mm</i>		<i>With 57mm uPVC threshold, max height 2211mm, min 1931mm</i>																															
Heritage Slam Lock with Leaf Only	Less 96mm from complete door with frame Available for Liniar and Kommerling Profile only. Min Leaf Height 1900mm <i>Including 1200 pull handle, 600 curved handle and Slendertech handle</i>																																
Heritage Slam Lock with Frame	Min Size 878 - <i>Avant Garde</i> - Barcelona, Milan, Madrid, Matisse, Gauguin Min Size 911 - Paris, London, Rome, Viking, Edinburgh, Seville, T&G, Picasso, Rubens, Turner, Orpen, Monet, Joyce, Oxford, Belfast, Albany, Cashel, Glasgow, Kensington Min Size 901 - Dublin, Giza, Santiago, Cambridge, Kildare																																
Heritage Slam Lock And Frame With Escutcheon	Min Size 878 - <i>Avant Garde</i> - Barcelona, Milan, Madrid, Matisse, Gauguin Min size 916 - Georgian, Naples, Cairo, Palermo Min size 891 - Sunbeam, T&G, Paris, London, Rome, Viking, Edinburgh, Seville, Picasso, Rubens, Turner, Orpen, Monet, Joyce, Oxford, Belfast, Albany, Cashel, Glasgow, Kensington Min size 901 - San Marco, Dublin, Giza, Santiago, Cambridge, Kildare																																
Warning	<i>Doors fitted with a Heritage Slam lock, it is recommended to have a PVC Threshold or Storm Guard Plus Rebated Threshold only.</i> <b>Please Note : Not A Storm Guard or a Storm Guard Plus Threshold</b>																																
U Value rating	Door body U Value - 0.205, Triple glaze U value - 1.1, combined U value - 0.64 Solid Door U Value including frame - 0.85 / Glazed Door U Value including frame - 0.98																																
Palladio Triple Glazing	Triple glazed units using warm edge, available in all doors. Backing glass, available as standard in Clear, Cotswold, Minister, Stippolyte and Flemish. * other obscure glass available optional extra (time delay). All satinized triple glazed units available with clear glass only.																																
Avant Garde Triple Glazing,	Backing glass, available as standard in Clear, Stippolyte, Minster, Flemish and Satin. Please note Glass units are not replaceable TG502, TG504, TG505, TG507, TG508 Not available with Midrails or Toplights, available Full length only																																
Lock type	2 hook 2 shootbolt 4 roller and deadlatch / Heritage Slam lock optional extra / PAS 23/24 Approved Thumb turns to be used with the Heritage Slam lock All door locks have a 12 month guarantee																																
Door numerals Avant Garde numerals	Supply only available 0-9 in Gold, Chrome, Black, Brushed Steel and Smokey Chrome. Brushed steel only.																																
Warning	In the event of a door being fitted behind a Glazed Patio Door, the area needs to be well ventilated to prevent the excessive build up of heat. Due to the manufacturing process Satinized designs and Flemish glass may have imperfections as the raw material is prone to slight blemishes.																																
Hardware	High quality handle, letter plate, urn door knocker solid or with spyview, all available with 5 year warranty. <b>MANUFACTURED TO BS 7412. Please Note: Letterboxes can be fitted at the bottom of all doors if requested, this however is not compliant with building regulations.</b>																																
Avant Garde Hardware Hardware Colour	Avant Garde brushed steel lever handle only. <i>(Please note letterbox and door knocker not available)</i> Black, Gold, Bright Chrome, Brushed Steel, Smokey Chrome and White. <i>(Please note gold and chrome handle and letterbox may vary slightly in colour from the doctor knocker.)</i>																																
Handle Maintenance	Stainless pull handles must be maintained every few months with soap and water to avoid discolouration. Do not use any abrasive cleaners																																
Hinge type	Rebated hinge available White, Caramel, Black and Cream																																
PVC outerframe Sculptured	70mm with galvanized steel reinforcing																																
Threshold	Extra strong - standard and low thresholds available																																

*Please note, owing to the photographic and printing process used, colour may vary from the printed brochure. Images shown are for illustrative purposes only. Actual product appearance and placement of furniture may vary*



# Accessories

## Threshold Options



**77mm uPVC Full Frame Threshold**  
Distance from bottom of door leaf to bottom of threshold - 48mm



**57mm uPVC Low Threshold**  
Distance from bottom of door leaf to bottom of threshold - 28mm



**Stormguard Low Aluminium Threshold**  
Distance from bottom of door leaf to bottom of threshold - 20mm.  
Available in Gold and Silver.



**Stormguard Plus Threshold**  
Distance from bottom of door leaf to bottom of threshold - 38mm.  
Available in Silver only.



**Stormguard Plus Rebated Threshold**  
Distance from bottom of door leaf to bottom of threshold - 20mm.  
Available in Silver only.  
(Not wheelchair accessible)



Slendertech Handle

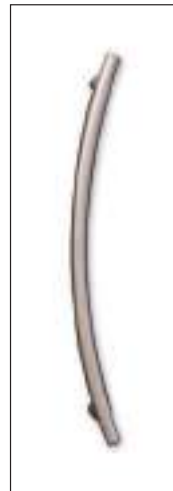

600mm Curved Handle

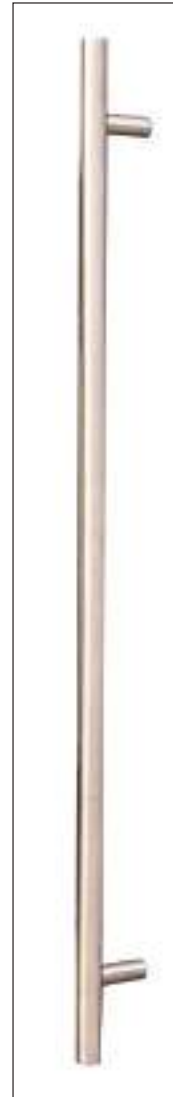

1200mm Offset Handle



**High Security Cylinder (optional extra)**  
Superior physical strength - Cylinder design that prevents lock bumping  
Anti-snap now with break points allowing interior key to work even if external snap damage occurs



Yale

The Mantis 3 Lock can be used with a Lever Lever or Lever Pad handle, the lock consists of ten locking points, four roller cams, two linear bolts, two hooks, a thumb latch and a dead bolt.

**GU Automatic Electric Lock**  
The GU Automatic lock gives automatic security. Simply close the door, 2 latches automatically throw and become rigid deadbolts which are locked against being forced back.

## Heritage Slam Lock



**Heritage Slam Locking System**  
An automatic 5 point locking system which is operated as soon as the door closes.

## Stainless Steel Furniture

High quality, long lasting, corrosion resistant.  
Available in 4 Stainless Steel finishes, Brushed steel, Gold, Chrome and smokey chrome,  
Available in lever and pad handles, letterbox's and urn door knockers for a fully coordinated look.



Doctors Knocker available only in Bright Chrome and Gold.  
Urn Knockers also available with Viewer

## Door Knockers



Doctors Knocker Chrome



Doctors Knocker Gold



Black



Gold



Bright Chrome



Brushed Steel



Smokey Chrome



White

## Letterbox



Black



Gold



Bright Chrome



Brushed Steel



Smokey Chrome



White

## Door Knobs



Gold finger pull



Bright chrome finger pull



Brushed steel finger pull



Gold



Bright Chrome



Brushed steel

## Door Handles



Black Lever



Gold Lever



Bright Chrome Lever



Brushed Steel Lever



Smokey Chrome Lever



White Lever



Black Lever Pad



Gold Lever Pad



Bright Chrome Lever Pad



Brushed Steel Lever Pad



Smokey Chrome Lever Pad



White Lever Pad

We have an extensive selection of furniture for our doors in various colours, enabling you to customise your door. Our designer handles add a stylish and contemporary look to our doors, ensuring customer satisfaction.

With Your Security And Safety In Mind

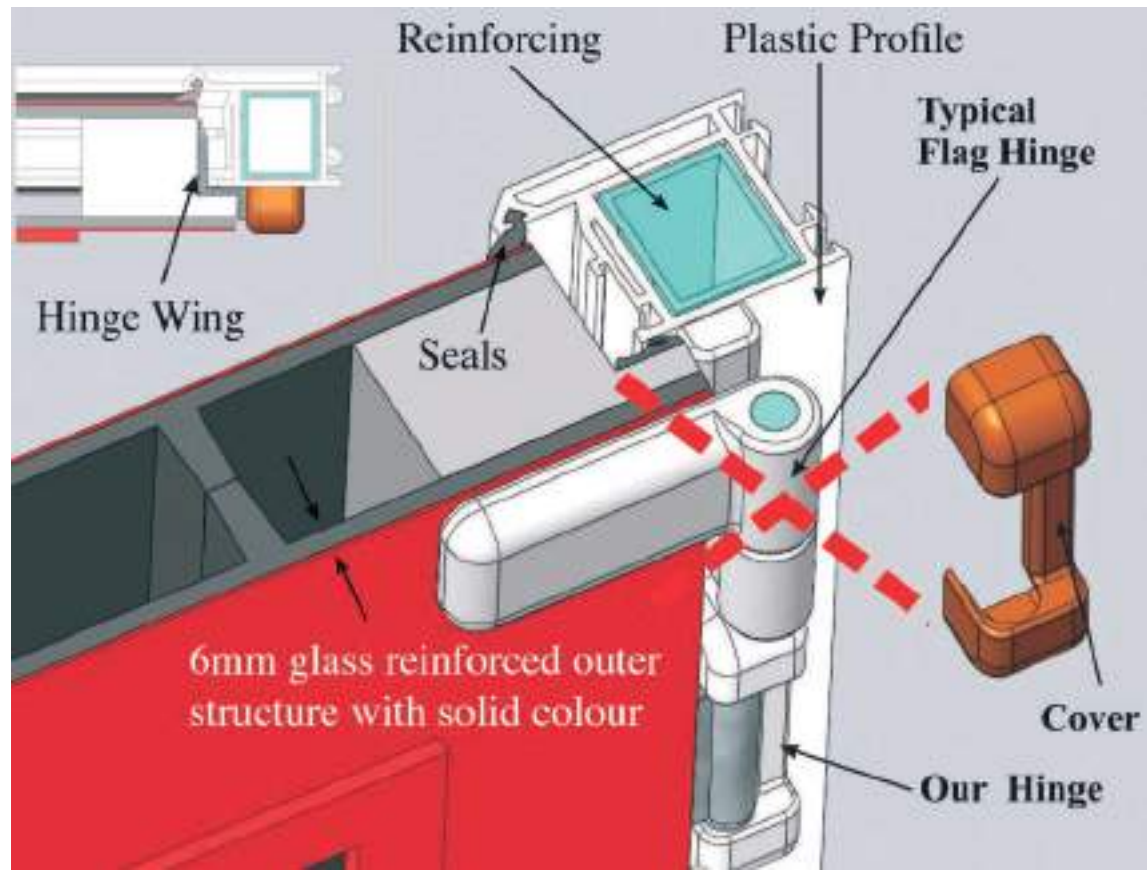

Above all we are a design and innovation led company and this will always shine through in the finished product. We start with the project design, then manufacture the machine we require and finally manufacture the product. Figure 1 shows the oak pattern from which the final mould will be produced.

This 3D generated photo demonstrates the advantage of our unique hinge. As is evident from the above picture, this hinge is not attached to the outside of the door, and therefore enhances the appearance of the door, unlike a more conventional flag hinge - as seen on the left. Double seal and rebate

*The Avant Garde Collection*

Here on the left you see our superior MONOCOQUE structure and the advantage it holds over its competitors as demonstrated on the opposite page.

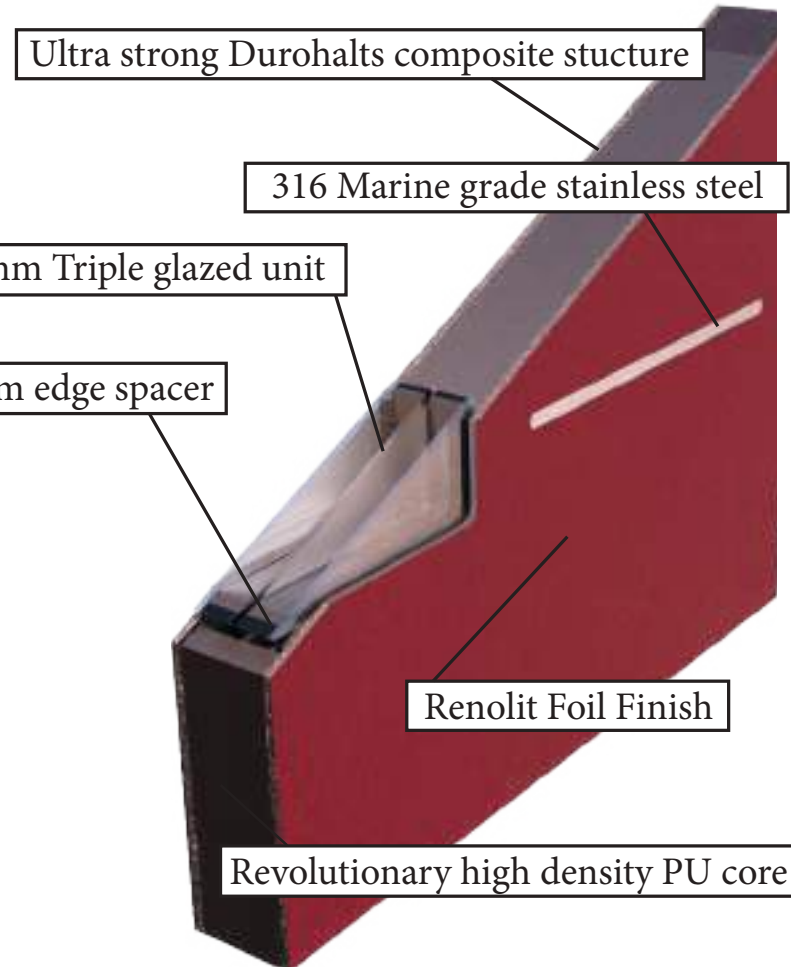

On the right we have produced a cut through section of the Avant Garde door with the revolutionary high density PU core along with a 56mm triple glazed unit. We have created an ultra strong Durohalts composite structure laminated to a Renolit foil finish on the surface, giving you massive strength and security to your home



The Picture above shows conventional composite doors, comprised of two 2mm skins bonded to a foam core.



To dispel any lingering doubt you may have, we have carried out our own rudimentary test using a 4x4 vehicle.

Figure 2 shows finished door from the original tooling.

Figure 3 is a good example of bad tooling design that lacks character.

On the other hand, compare this to Figure 4 which you can judge for yourself.

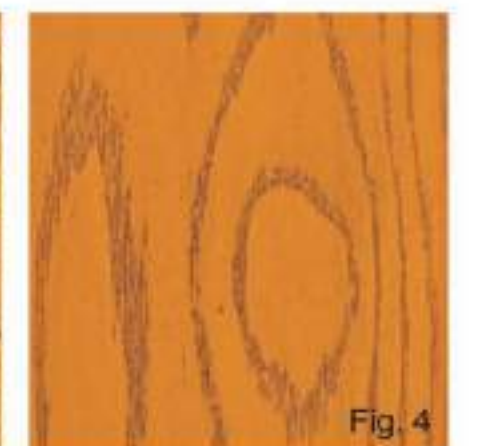
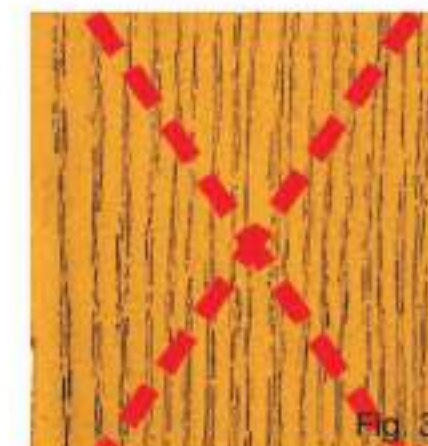

# *The Palladio Door Collection*

**GLIN, Co. LIMERICK, IRELAND**

Ireland Telephone: 00353-68-34312 (5 Lines) Fax: 00353-68-34492

United Kingdom Freephone 0808 234 0859

Website: [www.palladiodoorcollection.com](http://www.palladiodoorcollection.com) - Email: [info@profiledevelopments.com](mailto:info@profiledevelopments.com)

© Profile Developments have design copyright on all panel designs and glasswork designs



Scan this QR Code to go  
Directly to the website



Palladio Door Security Video  
Palladio Door Manufacturing Video  
and to see the full Range  
Log onto

[www.palladiodoorcollection.com](http://www.palladiodoorcollection.com)

Distributed by:

